

99313

Dimensions

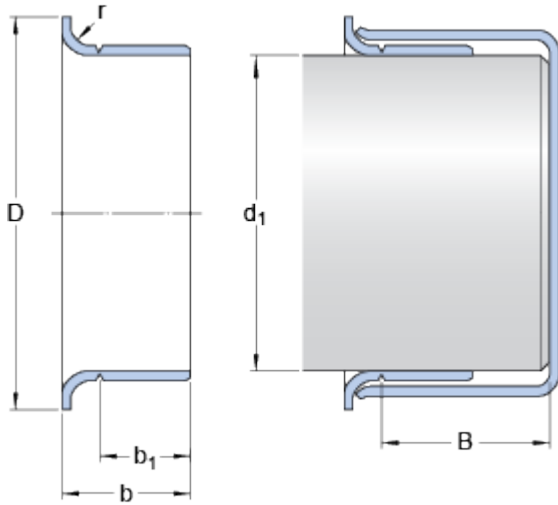

Nominal dimensions

d_1		80	mm
D		89.916	mm
Tolerance outside diameter D	\pm	1.6	mm
b		22.504	mm
Tolerance width b	\pm	0.8	mm
b_1		19.05	mm
Tolerance width b_1	\pm	0.8	mm
B	max.	34.925	mm
r	max.	3.18	mm

Shaft diameter range

d_1	min.	79.807	mm
d_1	max.	79.985	mm